

Model **WT3-201M**

---

MOTORIZED WIRE CRIMP PULL TESTER

# **User's Guide**

**MARK-10**<sup>®</sup>

*Thank you...*



Thank you for purchasing a Mark-10 WT3-201M wire crimp pull tester, designed for pull test applications up to 200 lbF (1,000 N).

With proper usage, we are confident that you will get many years of great service with this product. Mark-10 instruments are ruggedly built for many years of service in laboratory and industrial environments.

This User's Guide provides setup, safety, and operation instructions. Dimensions and specifications are also provided. For additional information or answers to your questions, please do not hesitate to contact us. Our technical support and engineering teams are eager to assist you.

**Before use, each person who is to use the WT3-201M should be fully trained in appropriate operation and safety procedures.**

**TABLE OF CONTENTS**

LIST OF INCLUDED ITEMS ..... 2

SAFETY ..... 2

SETUP ..... 2

HOME SCREEN AND CONTROLS ..... 5

OPERATING MODES ..... 8

UNITS OF MEASUREMENT ..... 8

DIGITAL FILTERS ..... 8

PASS / FAIL LIMITS ..... 9

SPEED ..... 10

AUTO START ..... 11

PRELOAD ..... 11

PULL TO LOAD ..... 12

LOAD HOLDING ..... 12

BREAK DETECTION ..... 13

AUTO SETTINGS ..... 13

DATA MEMORY AND STATISTICS ..... 14

COMMUNICATIONS AND OUTPUTS ..... 16

PROFILES ..... 19

PASSWORDS ..... 20

OTHER SETTINGS ..... 21

FUNCTION ACTIVATION ..... 23

CALIBRATION ..... 24

MAINTENANCE ..... 27

SPECIFICATIONS ..... 28

## 1 LIST OF INCLUDED ITEMS

---

Qty.	Part No.	Description
1	WT3-201M	Wire crimp pull tester
1	-	Power cord
1	-	Certificate of calibration without data (standard) or with data (optional)
1	09-1165	USB cable
1	-	Resource CD (USB driver, user's guides, MESUR™ Lite software, MESUR™ gauge DEMO software, User's Guide)

## 2 SAFETY

---

The following safety checks and procedures should be performed before and during operation:

1. Always consider the characteristics of the sample being tested before initiating a test. A risk assessment should be carried out beforehand to ensure that all safety measures have been addressed and implemented.
2. Wear eye and face protection when testing. Be aware of the dangers posed by potential energy that can accumulate in the sample during testing. Extra bodily protection should be worn if a destructive failure of a test sample is possible.
3. Keep away from moving parts of the tester. Loose articles of clothing should not be worn. Long hair should be covered to avoid a hazardous situation.
4. In those applications which could lead to a hazardous situation, use of a machine guard is strongly recommended.
5. When the tester is not in use, ensure that the power is turned off to prevent accidental engagement of any of the controls.

## 3 SETUP

---

### 3.1 Mechanical Setup

#### 3.1.1 Assembly

The tester is shipped completely assembled.

#### 3.1.2 Mounting

Place the tester on a clean, flat and level work area free from vibration. If desired, the tester can be secured to the work area with four 1/4-20 screws fastened into the threaded holes in the underside of the base (depth of 0.5 in. [12 mm]).

#### 3.1.3 Installing the ring terminal fixture or blank terminal fixture

To install or uninstall the standard terminal fixture or optional fixture, loosen the screw in the center of the fixture, remove, place the other fixture in the receptacle, and re-tighten the screw. Keep away from metal particles that may have originated from testing samples, as there are magnets located inside the terminal fixtures.

### 3.1.4 Sample setup

1. Secure the terminal into the standard terminal fixture or optional ring terminal fixture, as shown in the images below. Rotate the fixtures until the desired slot or ring size is aligned with the cam mechanism adjacent to the lever.

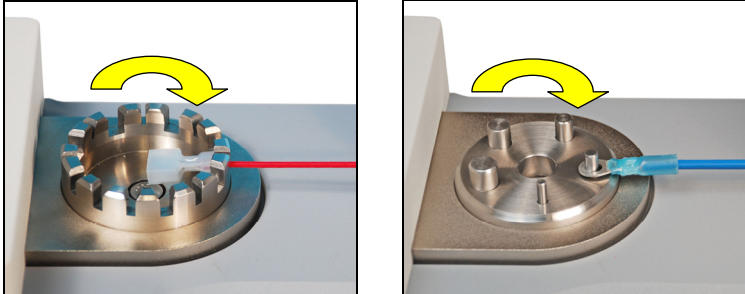

2. Insert the loose end of the wire between the cams in the mechanism. Keep the wire taut as it is inserted. If auto-start is enabled, the test will begin when the switch is activated (refer to later sections for operational details). Refer to the image below:

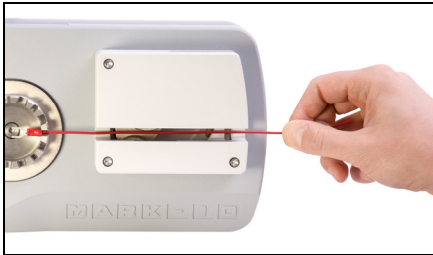

3. Note the protective red safety guard (circled, below), which automatically rotates into position as the cam mechanism closes.

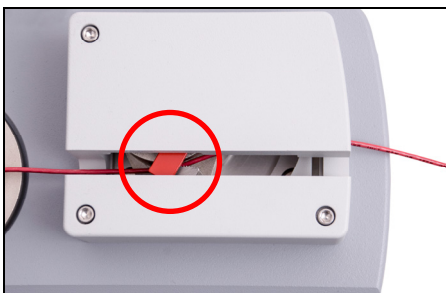

### 3.2 Connections and Outputs

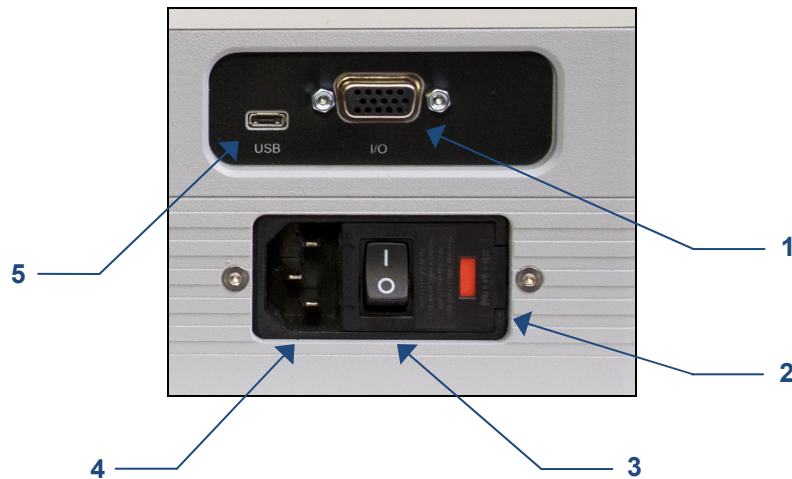

- 1. I/O Connector**  
RS-232, set point, analog, Mitutoyo, and other outputs are provided. Refer to the **Communications and Outputs** section for details.
- 2. Fuse**
- 3. Power Switch**  
Use to turn power on and off.
- 4. Power Plug Receptacle**  
Plug the power cord in here. Refer to the **Connecting power** sub-section for important safety information.
- 5. USB Connector**  
Plug the USB cable in here, for data output to a PC, PLC, printer, etc.

### 3.3 Installing the USB driver

If communicating via USB, install the USB driver provided on the Resource CD. Installation instructions may also be found on the CD or may be downloaded from [www.mark-10.com](http://www.mark-10.com).

#### **Caution!**

**Install the USB driver before physically connecting the tester to a PC with the USB cable.**

Further instructions for configuring and using the tester's outputs are provided in the **Communications and Outputs** section.

### 3.4 Connecting power

Plug one end of the power cord into its receptacle at the rear of the tester and the other end into a wall outlet with local earth ground (3-prong connector).

Before turning on power, the following safety checks and procedures should be performed:

1. Never operate the tester if there is any visible damage to the power cord or the tester itself. The WT3-201M is powered by 110V/220V. Any contact with this high voltage can cause serious injury or even death.

2. Ensure that the tester is kept away from water or any electrically conductive liquids at all times.
3. Make sure the electrical outlet powering the tester has local earth ground (3-prong connector).
4. The tester should be serviced by a trained technician only. Power must be disconnected before disassembly.

After the above safety checks and procedures have been performed, the tester may be powered on and is ready for operation.

## 4 HOME SCREEN AND CONTROLS

---

### 4.1 Demo Mode Functions

The WT3-201M is shipped in *Demo Mode*, which provides full functionality of all available optional functions for an evaluation period of 160 operating hours. When this period has expired, any functions not purchased will no longer be accessible.

After the initial power-up sequence, the display appears as follows:

\*\*\* DEMO MODE \*\*\*

All functions are temporarily enabled.  
Remaining demo time:  
160 hours  
Press ENTER.

The available optional functions are as follows:

1. **Profiles**  
Save and recall sets of test parameters, such as speed, pass/fail limits, unit of measurement, etc. Maximum of 500 profiles may be stored.
2. **Load Holding**  
The tester will stop and maintain a specified load for a specified period of time.
3. **Pull To Load**  
The tester will stop when the specified load has been reached.
4. **Date & Time Stamp**  
A date and time stamp is assigned to each saved data point.

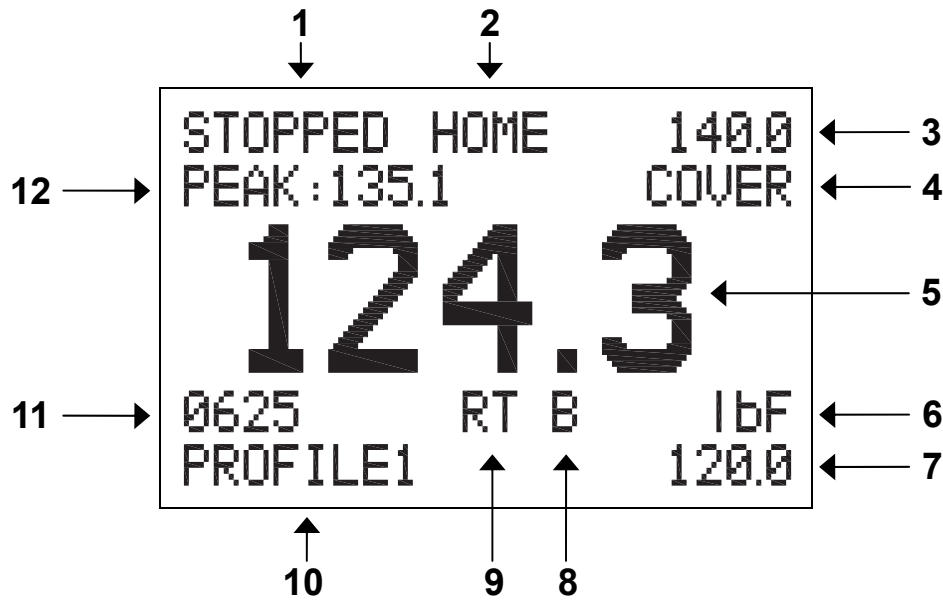

Refer to the **Function Activation** section for further instructions on how to activate functions.

4.2 Home Screen



No.	Name	Description
1	Status	Indicates one of the following statuses: STOPPED PULLING RETURNING (to the Home position) HOLDING (Load Holding sequence in progress)
2	Position	Indicates one of the following positions: HOME or LIMIT
3 / 7	Upper / lower force limits	Indicates the upper and lower acceptable force limits, as configured in the <b>Pass / Fail Limits</b> menu. The upper and lower <b>red</b> "X" indicators adjacent to the values illuminate if the displayed force is less than the lower limit or greater than the upper limit. The <b>green</b> "checkmark" indicator illuminates if the displayed force is within range.
4	Message	Indicates one of the following messages: COVER - the actuator cover is removed. PL ON – Pull to Load (optional function) is active. LH ON – Load Holding (optional function) is active.
5	Primary reading	The current displayed reading. See <b>Operating Modes</b> section for details.
6	Unit of measurement	The current measurement unit. Abbreviations are as follows: lbF – Pound-force ozF – Ounce-force kgF – Kilogram-force N – Newton kN – Kilonewton
8	Break detection on/off	The letter "B" appears if the Break Detection function is enabled. Refer to the <b>Break Detection</b> section for details.
9	Mode	The current measurement mode. Abbreviations are as follows: RT – Real Time PK – Peak See <b>Operating Modes</b> section for details about each of these modes
10	Profile name	Indicates the currently selected profile. See <b>Profiles</b> section for details.
11	Number of data points	The number of data points stored in memory, up to 2,000.
12	Peak force	The maximum measured tension force. May be reset by pressing <b>ZERO</b> .

### 4.3 Controls

Primary Label	Primary Function	Secondary Label	Secondary Function
<b>ENTER</b>	Various uses, as described in the following sections.	-	
<b>ZERO</b>	Zeroes the primary reading and peaks.	 <b>(UP)</b>	Navigates up through the menu and sub-menus.
<b>MENU</b>	Enters the main menu.	<b>ESCAPE</b>	Reverts one step backwards through the menu hierarchy.
<b>MODE</b>	Toggles between measurement modes.	 <b>(DOWN)</b>	Navigates down through the menu and sub-menus.
<b>DATA</b>	Stores a value to memory, transmits the current reading to an external device, and/or initiates automatic data output, depending on setup.	<b>DELETE</b>	Enables and disables <b>Delete</b> mode while viewing stored data.
<b>START</b>	Starts motion. Press and release to produce maintained motion. In <b>Maintenance</b> mode, a key press results in momentary motion.	-	
<b>STOP</b>	Stops motion.	<b>RETURN</b>	Reverses motion. Press and release to produce maintained motion until return to the Home position. In <b>Maintenance</b> mode, a key press results in momentary motion.

### 4.4 Menu navigation basics

Most of the tester's various functions and parameters are configured through the main menu. To access the menu press **MENU**. Use the **UP** and **DOWN** keys to scroll through the items. The current selection is denoted with clear text over a dark background. Press **ENTER** to select a menu item, then use **UP** and **DOWN** again to scroll through the sub-menus. Press **ENTER** again to select the sub-menu item.

For parameters that may be either selected or deselected, press **ENTER** to toggle between selecting and deselecting. An asterisk (\*) to the left of the parameter label is used to indicate when the parameter has been selected.

For parameters requiring the input of a numerical value, use the **UP** and **DOWN** keys to increment or decrement the value. Press and hold either key to auto-increment at a gradually increasing rate. When the desired value has been reached, press **ENTER** to save the change and revert back to the sub-menu item, or press **ESCAPE** to revert back to the sub-menu item without saving. Press **ESCAPE** to revert one step back in the menu hierarchy until back into normal operating mode.

Refer to the following sections for details about setting up particular functions and parameters.



## 5 OPERATING MODES

### Caution!

In any operating mode, if the capacity of the tester has been exceeded by more than 10%, the display will show "OVER" to indicate an overload. A continuous audible tone will be sounded until the MENU key has been pressed or the load has been reduced to a safe level.

Three operating modes are possible with the WT3-201M. To cycle between the modes, press **MODE** while in the home screen.

### 5.1 Real time (RT)

The primary reading corresponds to the live measured reading.

### 5.2 Peak (PK)

The primary reading corresponds to the peak tension reading observed. If the actual force decreases from the peak value, the peak will still be retained in the primary reading area of the display. Pressing **ZERO** will reset the value.

## 6 UNITS OF MEASUREMENT

The WT3-201M can display five different force measurement units. To change the unit, select **Units** from the menu. The display will list the available units, as follows:

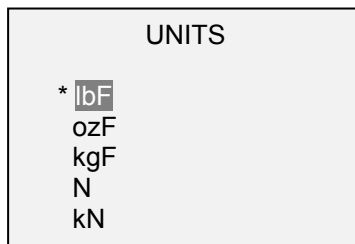

**Note:** Changing the unit within this menu will not set the default unit. To always power on automatically with the desired unit, configure the unit in the **Initial Settings** menu.

## 7 DIGITAL FILTERS

Digital filters are provided to help smooth out the readings in situations where there is mechanical interference in the work area or test sample. These filters utilize the moving average technique in which consecutive readings are pushed through a buffer and the displayed reading is the average of the buffer contents. By varying the length of the buffer, a variable smoothing effect can be achieved. The selection of 1 will disable the filter since the average of a single value is the value itself.

To access digital filter settings, select **Filters** from the menu. The display appears as follows:

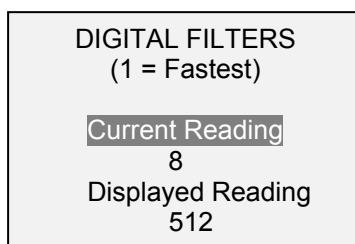

Two filters are available:

**Current Reading** – Applies to the peak capture rate of the instrument.

**Displayed Reading** – Applies to the primary reading on the display.

Available settings: 1,2,4,8,16,32,64,128,256,512,1024. It is recommended to keep the current reading filter at its lowest value for best performance, and the displayed reading filter at its highest value for best stability.

## 8 PASS / FAIL LIMITS

### 8.1 General Information

Pass / fail limits are useful for tolerance checking with red and green indicators and audible tones. Outputs are also provided, for triggering an external device such as an indicator or alarm in process control applications. Two limits, high and low, are specified and stored in the non-volatile memory of the tester and the primary reading is compared to these limits. The results of the comparisons are indicated through the three outputs provided on the 15-pin connector, thus providing “under”, “in range”, and “over” signaling.

### 8.2 Configuration

To configure pass/fail limits, select **Pass / Fail Limits** from the menu. The display appears as follows:

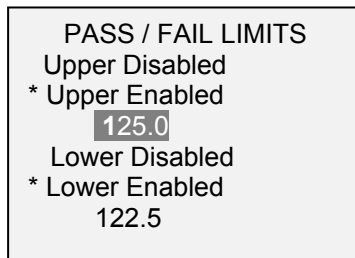

Either one, two, or none of the limits may be enabled.

The upper limit is displayed in the upper right corner of the display, and the lower limit is displayed in the lower right corner, as shown in the **Home Screen and Controls** section. If only one limit has been enabled, the word “OFF” appears in place of the other limit value. If neither limit has been enabled, the upper and lower right corners of the display will be blank.

If the application only requires that a sample withstand a minimum specified force, set only the lower pass/fail limit. If the value is below this limit, the lower **red** “X” illuminates. If the value is above this limit, the **green** “checkmark” illuminates.

**Note:** Pass / fail limits and set point outputs reference the displayed reading, not necessarily the current live load.

8.2.1 Set Point Outputs Schematic Diagram

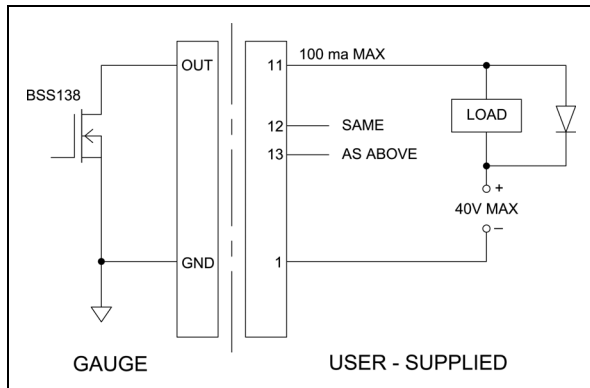

9 SPEED

The speed may be adjusted to comply with various standards and test methods. Select **Speed** from the menu and press **ENTER**. The display appears as follows:

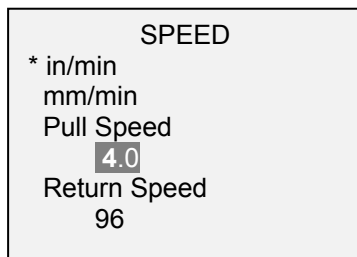

<b>in/min or mm/min</b>	Select inches per minute or millimeters per minute
<b>Pull Speed</b>	Sets the speed at which the test takes place. Available settings: <i>0.4 – 12.0 in/min, in 0.1 increments, or 10 – 300 mm/min, in 0.5 mm increments</i>
<b>Return Speed</b>	Sets the return speed. This speed applies to a manual press of the <b>RETURN</b> key or the Auto Return sequence. Available settings: <i>12 – 96 in/min, in 1 in/min increments, or 300 – 2,400 mm/min, in 25 mm/min increments</i>

## 10 AUTO START

Auto start increases testing efficiency by automatically starting the test when the sample has activated the switch, identified below:

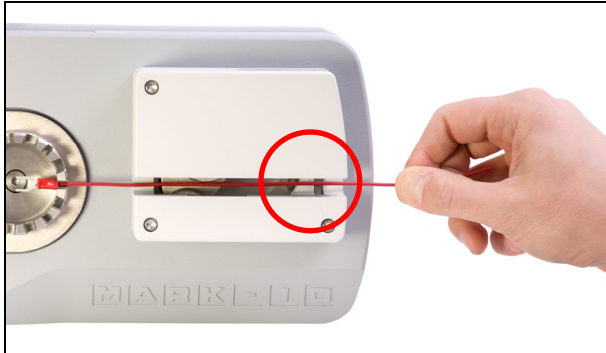

To use Auto start, select **Auto Start** from the menu and press **ENTER**. The display appears as follows:

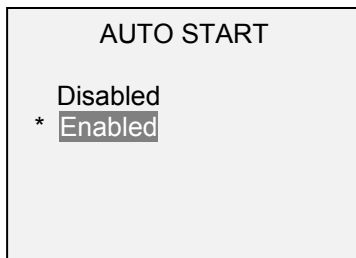

Select **Enabled**. It is recommended to combine **Auto Start** with **Break Detection** and **Auto Return** automation functions for maximum efficiency. Refer to the following sections for details.

## 11 PRELOAD

To improve testing efficiency, the initial speed may be faster than the test speed. When the mechanism engages the sample, definable as a preload, the speed reverts to the programmed test speed. Select **Preload** from the menu and press **ENTER**. The display appears as follows:

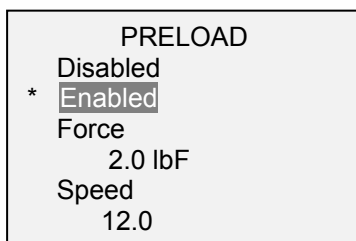

<b>Enabled</b>	Enables the Preload function.
<b>Force</b>	Sets the force at which the speed reverts to the programmed test speed. Available settings: 1 – 100 lbF, in 0.1 lbF increments (or equivalent range in other units)
<b>Speed</b>	Sets the initial speed until preload. Available settings: 12 – 96 in/min, in 1 in/min increments, or 300 – 2,400 mm/min, in 25 mm/min increments

After exiting the menu, press **ZERO** to arm the function.

**Note:** To avoid overshoot in Load Holding or Pull to Load, make sure the preload force is set well below the expected testing force. Some experimentation may be necessary for optimization depending on the wire sample's elasticity. The same is true for the preload speed.

## 12 PULL TO LOAD *(optional function)*

For non-destructive testing and other applications, the tester can stop when a specified load has been reached. Select **Pull to Load** from the menu and press **ENTER**. The display appears as follows:

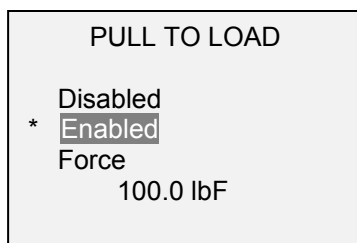

<b>Disabled</b>	Disables the Pull to Load function.
<b>Enabled</b>	Enables the Pull to Load function.
<b>Force</b>	Sets the force at which the tester stops. Available settings: 0 – 200 lbF, in 0.1 lbF increments (or equivalent range in other units)

After exiting the menu, press **ZERO** to arm the function. The message changes from “LL” to “LL ON” in the upper right corner of the display.

The tester can perform a number of additional automatic functions upon completion of a pull to load sequence, further described in the **Auto Settings** section.

## 13 LOAD HOLDING *(optional function)*

Load Holding addresses certain test methods requiring a specified load to be maintained for a specified period of time, such as UL 486A/B. The motor dynamically reacts to changes in load, such as sample relaxation, in order to maintain the specified for the duration of the test. Select **Load Holding** from the menu and press **ENTER**. The display appears as follows:

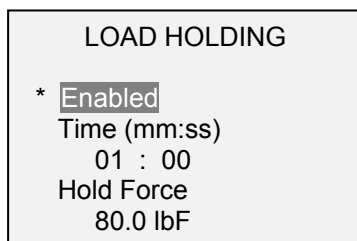

<b>Enabled</b>	Enables the Load Holding function.
<b>Time</b>	Sets the period of time for which the tester maintains the load. Available settings: 0 – 60 minutes, in 1 second increments
<b>Hold Force</b>	Sets the force which the tester will maintain for the specified period of time. Available settings: 0 – 200 lbF, in 0.1 lbF increments (or equivalent range in other units)

After exiting the menu, press **ZERO** to arm the function. The message changes from “LH” to “LH ON” in the upper right corner of the display. When the test has started, a counter appears on the top center of the screen, showing the remaining time.

The tester can perform a number of additional automatic functions upon completion of a Load Holding sequence, further described in the **Auto Settings** section.

## 14 BREAK DETECTION

The break detection function senses when the wire-terminal separation occurs. A break is defined as a force increasing beyond a configured force threshold, then decreasing to 2 lbf (or equivalent value in other units). Upon detection of the break, the tester can stop and return at full speed to the Home position, if **Auto Return** is enabled.

The tester can perform a number of additional automatic functions upon sample break, further described in the **Auto Settings** section.

Break detection functions and settings are configured from a central location, and apply to any mode in which it is enabled. Refer to the **Operating Modes** section for details on configuring each mode.

### 14.1 Configuration

To enable Break Detection, select **Break Detection** from the main menu. The display appears as follows:

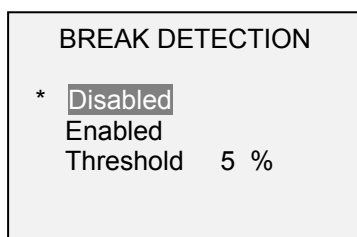

Any combination of the above functions may be selected.

Function	Description
<b>Enabled</b>	Enables the break detection function. When enabled, the letter “B” appears on the home screen, between the Mode and Unit indicators. Refer to the <b>Home Screen and Controls</b> section for details.
<b>Threshold</b>	Sets the percentage of full scale at which the break detection function becomes active. This threshold is provided to ignore peaks that can occur during sample loading and unloading. Available settings: 1-90%, in 1% increments.

After exiting the menu, press **ZERO** to arm Break Detection. The message at the bottom of the screen changes from “B” to “B ON”.

If tones are enabled, a tone will sound when the output, storage, and zero functions have been triggered.

## 15 AUTO SETTINGS

The tester can perform one or several functions automatically when it has returned to the Home position. Return to Home can occur after a simple manual reverse, Auto Return, or a special event such as Break Detection, Pull to Load, or Load Holding:

The following automatic functions are available

1. Save the peak value to memory.
2. Transmit the peak reading.
3. Toggle an output pin.
4. Zero the primary and peak readings after a settable delay.

Scroll to **Auto Settings** in the menu and press **ENTER** to set the value. The display appears as follows:

AUTO SETTINGS * Enabled * Memory Storage * RS232/USB Output Mitutoyo Output + More	AUTO SETTINGS 2 Output Pin: NONE * Auto Zero Auto Zero Delay 5 sec.
---	---

<b>Enabled</b>	When enabled, all individual settings marked with an asterisk are active. When disabled, all settings are globally disabled, regardless of asterisks.
<b>Memory Storage</b>	Stores the peak reading to memory.
<b>RS232/USB Output</b>	Outputs the peak and date / time stamp (if this function is installed) via RS-232 and USB.
<b>Mitutoyo Output</b>	Outputs the peak via Mitutoyo.
<b>Output Pin</b>	Output Pin sets the selected SP1, SP2, or SP3 pin low until <b>ZERO</b> is pressed, after which it reverts back to following the pass/fail limits if enabled. If not required, select "NONE".
<b>Auto Zero</b>	Zeroes the display.
<b>Auto Zero Delay</b>	Automatic zero is delayed for the specified period of time following return to the Home position.

## 16 DATA MEMORY AND STATISTICS

The WT3-201M has storage capacity of 2,000 data points. Readings may be stored, viewed, and output to an external device. The most recent data point may be deleted. Statistics are calculated for the data presently in memory.

To enable memory storage, select **DATA Key** from the menu, then scroll to **Memory Storage** and press **ENTER**. Then exit the menu. In the home screen, the data record number **0000** appears below the primary reading. Press **DATA** at any time to save the displayed reading. The record number will increment each time **DATA** is pressed. If **DATA** is pressed when memory is full the message "MEMORY FULL" will be flashed at the bottom of the display and a double audio tone will be sounded.

To view, edit, and output stored readings and statistics, select **Memory** from the menu. The display appears as follows:

MEMORY View Data View Statistics Output Load Data Output Full Data Output Statistics Clear All Data
---

### 16.1 View Data

All the saved data points may be viewed. The record number is displayed, along with the corresponding value and presently set unit of measurement.

0001	24.8 lbF
0002	22.2 lbF
0003	24.6 lbF
0004	18.9 lbF
0005	20.0 lbF
0006	19.9 lbF
0007	20.2 lbF

#### 10.1.1 Date & Time Stamp

If the optional **Date & Time Stamp** function is installed, pressing **ENTER** for the highlighted data point will display the associated date and time stamp, as well as the profile name (if the optional **Profiles** function is installed). The display appears as follows:

Data Point:	0005
Load:	20.0 lbF
Date:	01/20/2015
Time:	11:35:08 AM
Prof:	PROFILE123

### 16.2 Delete Data

The last data point may be deleted. To do so, press **DELETE** while highlighting the last data point (Pressing **DELETE** while highlighting any other data point will have no effect). The letter "D" appears to the left of the record number, indicating that the reading was marked for deletion, as follows:

0001	24.8 lbF
0002	22.2 lbF
0003	24.6 lbF
0004	18.9 lbF
0005	19.9 lbF
D 0006	20.0 lbF

Press **ENTER** to delete the value. The next most recent data point can then be deleted in the same fashion. To exit **Delete** mode, press **DELETE** again. To delete all data points, refer to the **Clear All Data** section.

### 16.3 Statistics

Statistical calculations are performed for the saved values. Calculations include number of readings, minimum, maximum, mean, and standard deviation.

### 16.4 Output Load Data

Press **ENTER** to output data to an external device. The display will show, "SENDING DATA...", then "DATA SENT". If there was a communication problem, the display will show, "DATA NOT SENT". Saved data can be downloaded to Mark-10 data collection programs. Refer to their respective user's guides for details.



### 16.5 Output Full Data

Press **ENTER** to output data plus time, date, and profile name to an external device (optional **Profiles** and **Date & Time Stamp** functions required). The display will show, "SENDING DATA...", then "DATA SENT". If there was a communication problem, the display will show, "DATA NOT SENT". Saved data can be downloaded by Mark-10 data collection programs. Refer to their respective user's guides for details.

### 16.6 Output Statistics

Press **ENTER** to output statistics to an external device. The display will show, "SENDING STATS...", then "STATS SENT". If there was a communication problem, the display will show, "STATS NOT SENT".

### 16.7 Clear All Data

Press **ENTER** to clear all data from the memory. A prompt will be shown, "CLEAR ALL DATA?". Select **Yes** to clear all the data, or **No** to return to the sub-menu.

**Note:** For convenience, clearing all data can also be accomplished by highlighting **Memory** in the main menu, then pressing **DELETE**.

## 17 COMMUNICATIONS AND OUTPUTS

Communication with the WT3-201M tester is achieved through the micro USB or 15-pin serial ports, as shown in the illustration in the **Power** section. Communication is possible only when the tester is in the main operating screen (i.e. not in a menu or configuration area).

### 11.1 Serial / USB

To set up RS-232 and USB communication, select **Serial/USB Settings** from the menu. The display appears as follows:

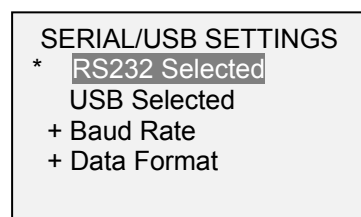

Select either RS-232 or USB input (output is always simultaneous through both the USB and RS-232 ports). Communication settings are permanently set to the following:

**Data Bits:** 8  
**Stop Bits:** 1  
**Parity:** None

Other settings are configured as follows:

#### 11.1.1 Baud Rate

Select the baud rate as required for the application. It must be set to the same value as the receiving device.

#### 11.1.2 Data Format

Select the desired data format. The display appears as follows:

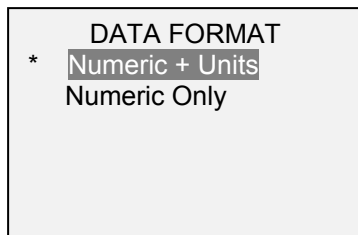

Selection	Description
Numeric + Units	Output format includes the value and unit of measure.
Numeric Only	Output format includes the value only.

11.1.3 Data Communication

Individual data points may be transmitted by pressing **DATA**. The WT3-201M may also be controlled by an external device through the RS-232 or USB channels. The following is a list of supported commands and their explanations. All commands must be terminated by a CR (Carriage Return) character, 0x0D, or a CR-LF (Carriage Return – Line Feed) pair, where the Line Feed, 0x0A, is ignored.

- ? Request the displayed reading
- MEM Transmit all stored readings, without date, time, or profile name
- MEMFL Transmit all stored readings, with date, time, and profile name
- STA Transmit statistics
- CLRMEM Clear all stored readings from memory

11.1.4 Command Responses

In response to the reading request command '?' the tester will return a string with the load data, followed by a space, then the load unit (if enabled, as described above). It will be terminated by a CR-LF pair.

Example return string:  
 124.8 lbF<CR><LF> 124.8 lbF of pull force

Any detected errors are reported back by means of error code \*10 (illegal command).

17.2 Mitutoyo BCD settings

This output is useful for connection to data collectors, printers, multiplexers, or any other device capable of accepting Mitutoyo BCD data. Individual data points may be transmitted by pressing **DATA** or by requesting it from the Mitutoyo device (if available). The display appears as follows:



17.3 Analog Output

This output can be used for chart recorders, oscilloscopes, data acquisition systems, or any other compatible devices with analog inputs. The output produces -1VDC at full scale of the tester.

17.4 DATA Key Functions

The **DATA** key can be configured to perform several functions. To configure the **DATA** key, select **DATA Key** from the menu. The display appears as follows:

DATA KEY	
*	RS232/USB Output
	Mitutoyo Output
*	Memory Storage
	Profile Name Out.
	Date Output
	Time Output

Three options are available:

Selection	Function when pressing DATA
<b>RS232/USB Output</b>	Outputs data via the serial and USB ports
<b>Mitutoyo Output</b>	Outputs data via Mitutoyo (Digimatic) through the serial port
<b>Memory Storage</b>	Stores a reading to memory (refer to the <b>Memory</b> section for details)
<b>Profile Name Out.</b>	Outputs the Profile name ( <i>requires optional Profiles function</i> )
<b>Date Output</b>	Outputs the date stamp ( <i>requires optional Date &amp; Time Stamp function</i> )
<b>Time Output</b>	Outputs the time stamp ( <i>requires optional Date &amp; Time Stamp function</i> )

Any combination of the above functions may be selected.

### 17.5 I/O Connector Pin Diagram (DB-9HD-15 female)

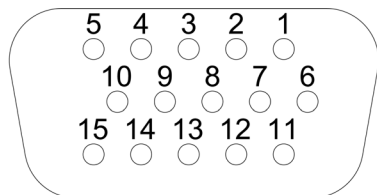

Pin No.	Description	Input / Output
1	Signal Ground	---
2 *	Tension Overload *	Output *
3	RS-232 Receive	Input
4	RS-232 Transmit	Output
5	+12V DC	Input / Output
6	Analog Output	Output
7	---	---
8	Mitutoyo Clock	Output
9	Mitutoyo Data or	Output
10	Mitutoyo Request or	Input
11	Set Point Pin 1 (SP1)	Output
12	Set Point Pin 2 (SP2)	Output
13	Set Point Pin 3 (SP3)	Output
14	---	---
15 *	Mitutoyo Ready	Output *

\* Maximum voltage: 40V.

## 18 PROFILES *(optional function)*

Groups of menu settings may be saved as profiles, and later recalled as required for the application. To save, edit, and recall profiles, select **Profiles** from the menu and press **ENTER**. The display appears as follows:

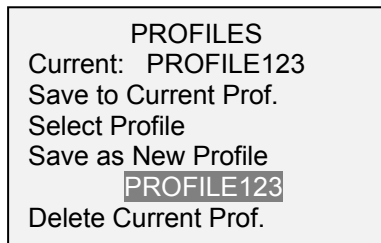

Selection	Description
Current	Indicates the currently selected profile. To rename it, press <b>ENTER</b> to highlight the name. The name may consist of up to 10 alphanumeric characters. Use the <b>▲</b> and <b>▼</b> keys to increment and decrement the characters, and the <b>DATA</b> key to advance to the next character. Press <b>ENTER</b> when done.
Save to Current Prof.	Save settings to the currently selected profile (overwrite the current profile).
Select Profile	View a list of saved profiles. Scroll through the list and press <b>ENTER</b> to select the desired profile. Any data saved in memory will be deleted when selecting a different profile.  <b>Note:</b> One of the profiles listed is named "NO PROFILE", which initially contains factory default settings. These settings can be edited, however, the profile name cannot be edited.
Save as New Profile	Save settings to a new profile. The name can be entered as described above.
Delete Current Prof.	Delete the currently selected profile. <b>Note:</b> "NO PROFILE" may not be deleted.

**Note:** If any settings are changed and the main menu is exited without first saving these changes to a new or current profile, the following message appears:

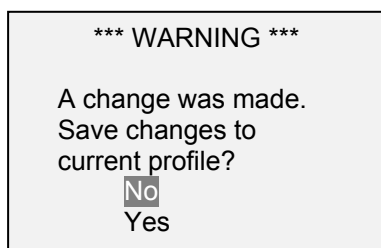

Selection	Description
No	Reverts to the home screen, and defaults to the profile "NO PROFILE".
Yes	Save settings to the currently selected profile (overwrite the current profile).

When exiting the **Profiles** menu, the profile name will be shown in the lower left corner of the home screen, except if "NO PROFILE" is selected, in which case this part of the screen will be blank.

## 19 PASSWORDS

Two separate passwords may be configured to control access to the Calibration section and to the menu and other keys. To access the passwords setup screen, select **Passwords** from the menu. The display appears as follows:

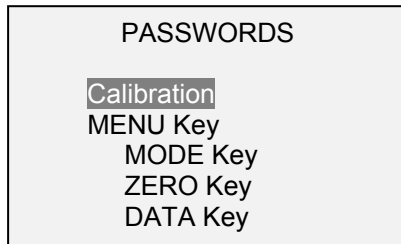

### 19.1 Calibration Password

Select **Calibration** from the sub-menu. The display appears as follows:

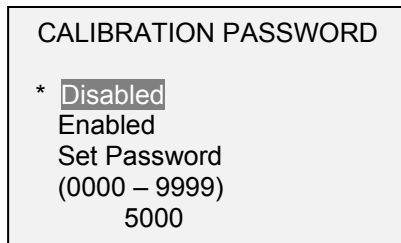

To set the password, select **Enabled**, then **Set Password**. Use the **UP** and **DOWN** keys to increment and decrement the value, from 0 to 9999. When the desired value has been selected, press **ENTER**, then **ESC** to exit the sub-menu.

### 19.2 MENU Key Password

If enabled, every time the **MENU** key is selected, a password must be provided. Select **MENU Key** from the sub-menu. Follow the same procedure as described in the previous sub-section.

### 19.3 Locking Out Other Keys

Other keys may be locked out individually. Select any combination of keys (**MODE**, **ZERO**, **DATA**) by pressing **ENTER** in the **Passwords** sub-menu. Pressing a locked key will prompt the message "KEY PROTECTED" and then revert to the previous screen.

### 19.4 Password Prompts

If passwords have been enabled, the following will be displayed when pressing the **MENU** key or accessing the **Calibration** section:

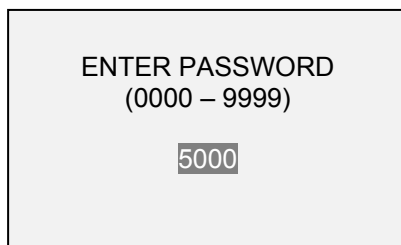

Use the **UP** and **DOWN** keys to select the correct password, then press **ENTER** to continue.

If the incorrect password has been entered, the display appears as follows:

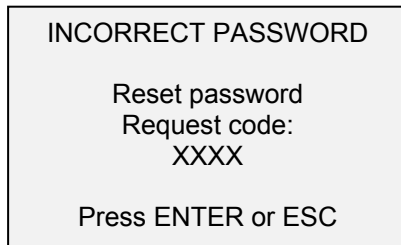

To re-enter the password, press ESC to exit to the home screen. Then, access the desired function and enter the password again when prompted.

If the password has been misplaced, it can be reset. Press **ENTER** to generate a *request code*. The *request code* must be supplied to Mark-10 or a distributor, who will then provide a corresponding *authorization code*. Enter the *activation code* to disable the password.

## 20 OTHER SETTINGS

### 20.1 Date & Time (optional function)

If the **Date & Time Stamp** function is installed, the date and time may be configured in the **Date & Time** menu. The display appears as follows:

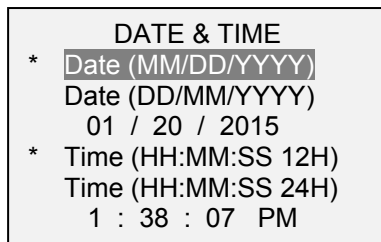

Select the preferred date and time formats by highlighting and pressing the **ENTER** key. Then use the **ENTER** key to scroll between the fields within the date and time. Use the ▲ and ▼ keys to increment and decrement the values. Pressing **ESC** will abort any changes.

### 20.2 LCD Contrast

The contrast of the display may be adjusted. Select **LCD Contrast** from the menu. The display appears as follows:



Press **ENTER** to modify the contrast. Select a value from 0 to 25, 25 producing the most contrast.

### 20.3 Tones

Audible tones can be enabled for all key presses and alerts, such as overload, pass/fail limit reached, etc. The pass/fail alert can be configured to be either a momentary tone or a continuous tone (until the load is

restored to a value between the fail limits). To configure the functions for which audible tones will apply, select **Tones** from the menu. The display appears as follows:

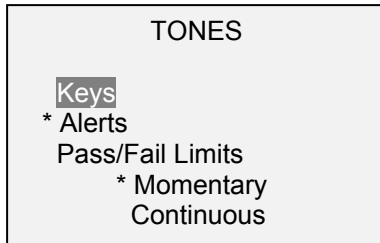

#### 20.4 Initial settings

This section is used to configure the initial settings upon powering on the tester. The initial units of measurement and the primary reading measurement mode may be configured. To access these settings, select **Initial Settings** from the menu. The display appears as follows:

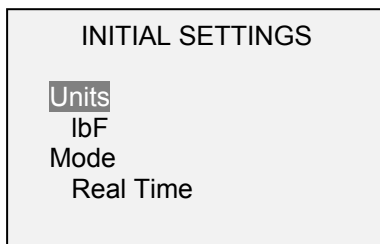

The default values are lbF and Real Time.

#### 20.5 Restore Default Settings

Default factory settings can be restored by selecting **Restore Defaults** from the menu. The settings may be found in the **Specifications** section. The display appears as follows:

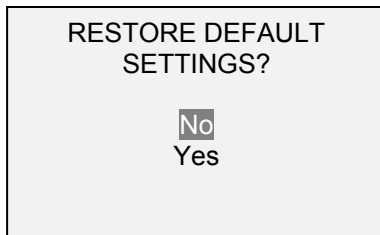

#### 20.6 Information / Welcome Screen

The following screen is displayed at power up and can be accessed at any time by selecting **Information** from the menu:

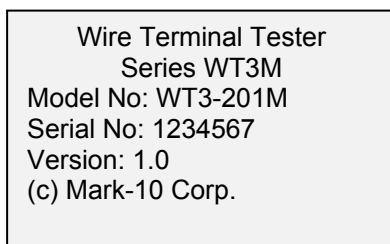

## 21 FUNCTION ACTIVATION

A number of optional functions are available, which may be ordered upfront or enabled in the field via an *activation code*.

### 21.1 Activating Functions

Select **Function Activation** from the menu. The display appears as follows:

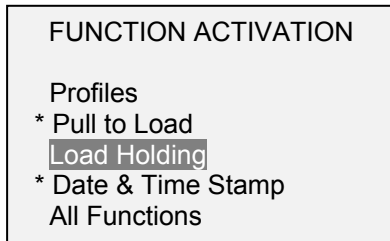

Functions marked with an asterisk are installed. To install another function, scroll to it, then press **ENTER**. The display appears as follows:



Supply the *request code* to Mark-10 or a distributor, who will then provide a corresponding *activation code* to activate the function. Use the ▲ and ▼ keys to select each character, then press **DATA** to advance to the next character. Press **ENTER** when done. If the code has been entered successfully, the function will be permanently installed.

### 21.2 Demo Mode Functions

The WT3-201M is shipped in *Demo Mode*, which provides full functionality of all available functions for an evaluation period of 160 operating hours. When this period has expired, any functions not purchased will no longer be accessible.

After the initial power-up sequence, the display appears as follows:





## 22 CALIBRATION

---

### 22.1 Initial Physical Setup

The tester should be mounted vertically to a fixture rugged enough to withstand a load equal to the full capacity of the instrument. Certified deadweights or master load cells should be used, along with appropriate mounting brackets and fixtures. A calibration kit is available from Mark-10. Caution should be taken while handling such equipment.

### 22.2 Calibration Procedure

1. Select **Calibration** from the menu. The display appears as follows:

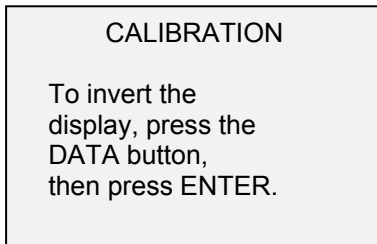

2. Press **DATA** to invert the display, if desired. **ENTER** to continue. The display appears as follows:

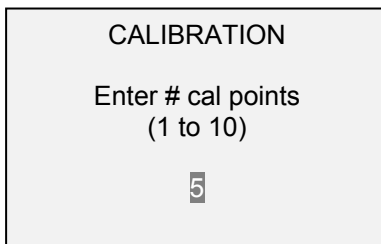

The tester can be calibrated at up to 10 points. Enter the number of calibration points (at least one point must be selected).

**Note:** To achieve the accuracy specification of  $\pm 0.2\%$ , it is recommended to calibrate the tester at 5 or more evenly spaced increments, such as 40, 80, 120, 160, and 200 lb loads.

3. To escape the **Calibration** menu at any time, press **ESCAPE**. The display appears as follows:

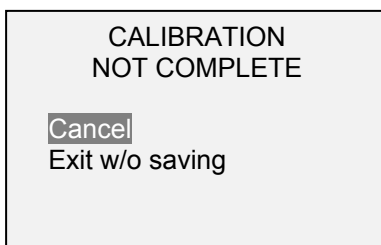

Selecting "Cancel" will revert back to the Calibration setup. Selecting "Exit w/o saving" will return to the menu without saving changes.

4. After the number of calibration points has been entered, press **ENTER**. The display appears as follows:

CALIBRATION  
OFFSET

Place force tester  
horizontal, then  
press ZERO.

- Place the tester horizontally on a level surface free from vibration, then press **ZERO**. The tester will calculate offsets, and the display appears as follows:

CALIBRATION  
OFFSET

Please wait...

CALIBRATION  
OFFSET

Sensor passed  
Analog passed

If failed:

CALIBRATION  
OFFSET

Sensor failed  
Analog failed

- The following message appears after the offsets have been calculated:

CALIBRATION

Attach necessary  
weight fixtures,  
then press ENTER.

Attach weight fixtures (brackets, hooks, etc), as required. Do not yet attach any weights or apply any calibration loads. Then press **ENTER**.

- The display appears as follows:

CALIBRATION

Optionally exercise  
sensor, then press  
ENTER.

Optionally exercise the load cell several times (at full scale, if possible), then press **ENTER**.

8. The display appears as follows:

```
CALIBRATION

Gain adjust
Apply full scale load
200.0 lbF +/-20%,
then press ENTER.
```

Apply a weight equal to the full scale of the instrument, then press **ENTER**.

9. After displaying "Please wait..." the display appears as follows:

```
CALIBRATION

Ensure no load,
then press ZERO.
```

Remove the load, leave the fixtures in place, then press **ZERO**.

10. The display appears as follows:

```
CALIBRATION

Apply load
1 OF 5
Enter load:
40.0 lbF
Press ENTER.
```

Use the **UP** and **DOWN** keys to adjust the load value as required. The load values default to evenly spaced increments, as indicated by the previously entered number of data points. Apply the calibration load. Then press **ENTER**.

Repeat the above step for the number of data points selected.

11. After all the calibration points have been completed, the display appears as follows:

```
CALIBRATION
COMPLETE

Save & exit
Exit w/o saving
```

To save the calibration information, select "Save & exit". To exit without saving the data select "Exit w/o saving".

12. Any errors are reported by the following messages:

CALIBRATION  
Units must be lbF.  
Please try again  
Press ENTER.

Displayed at the start of calibration if a disallowed unit is selected.

CALIBRATION  
Load not stable.  
Please try again.

Ensure that the load is not swinging, oscillating, or vibrating in any manner. Then try again.

CALIBRATION  
Load too low.  
Please try again.

The calibration weight does not match the set value.

CALIBRATION  
Load too close  
to previous.  
Please try again.

The entered calibration point is too close to the previous point.

## 23 MAINTENANCE

---

As wire terminals are removed, debris may fall into the cam mechanism area. This debris may be accessed by removing the cam mechanism cover. Ensure that the cam mechanism is in the maximum travel position (opposite the Home position) before removing the cover. Then loosen the three screws identified below, and **carefully lift the cover straight up**, ensuring that the auto-start switch (circled, below) is not damaged.



Use a small brush to collect and remove debris. To avoid possible damage to tester components, **DO NOT** use compressed air.

While the cover is removed, the status in the upper right corner will be flashing “COVER”. The **START** and **STOP** keys must be pressed and held to produce momentary motion. Normal testing cannot be performed while the cover is removed.

After reinstalling the cover, cycle the mechanism to the end of travel and back to the home position to ensure that the pinch guard has re-engaged.

## 24 SPECIFICATIONS

### 24.1 General

<b>Force capacity x resolution:</b>	200 x 0.1 lbF   3200 x 2 ozF   100 x 0.05 kgF   1000 x 0.5 N   1 x 0.0005 kN
<b>Accuracy:</b>	±0.2% of full scale
<b>Wire diameter range:</b>	AWG30 - AWG 3 [0.01 - 0.25 in (0.3 - 6.3 mm)]
<b>Min. sample length:</b>	Minimum 6.5 in [165 mm], excluding termination
<b>Max. elongation:</b>	1.7 in [43 mm]
<b>Speed range:</b>	0.4 - 12.0 in/min [10 - 300 mm/min]
<b>Sampling rate:</b>	7,000 Hz
<b>Speed setting accuracy:</b>	±0.2%
<b>Speed variation with load:</b>	±0% [Stepper motor driven]
<b>Power:</b>	Universal input 80-240 VAC, 50/60 Hz
<b>Fuse:</b>	1.2 A, 250V, 3AG, SLO BLO
<b>Outputs:</b>	<b>USB / RS-232:</b> Fully configurable up to 115,200 baud. <b>Mitutoyo (Digimatic):</b> Serial BCD suitable for all Mitutoyo SPC-compatible devices. <b>Analog:</b> -1 VDC, ±0.25% of full scale at capacity, <b>General purpose:</b> Three open drain outputs, one input. <b>Set points:</b> Three open drain lines.
<b>Safe overload:</b>	150% of full scale (display shows “OVER” at 110% and above)
<b>Weight:</b>	26.5 lb [12 kg]
<b>Included accessories:</b>	Power cord, quick-start guide, USB cable, resource CD (USB driver, MESUR™ Lite software, MESUR™ gauge DEMO software, and user's guide), and NIST-traceable certificate of calibration.
<b>Environmental requirements:</b>	40 - 100°F, max. 93% humidity, non-condensating
<b>Warranty:</b>	3 years (see individual statement for further details)

## 24.2 Factory Settings

Parameter	Setting
Pass / Fail Limits	Disabled
Upper	160 lbF
Lower	80 lbF
Filters	
Current	512
Displayed	1024
DATA Key Functions	
RS-232/USB Output	Enabled
Mitutoyo Output	Disabled
Memory Storage	Enabled
Profile Name Output	Disabled
Date Output	Disabled
Time Output	Disabled
Speed	
Pull Speed	4.0 in/min
Return Speed	96 in/min
Unit	in/min
Auto Return	Disabled
Auto Start	Disabled
Serial/USB	
RS-232 Output Selected	Enabled
USB Output Selected	Disabled
Baud Rate	9,600
Data Format	Numeric + units
Mitutoyo BCD Output	Disabled
Preload	Enabled
Force	5 lbF
Speed	50 in/min
Break Detection	Disabled
Threshold	10% of full scale
Auto Settings	
Auto Zero	Disabled
Auto Zero Delay	5 sec.
RS-232/USB Output	Disabled
Auto Storage	Disabled
Output Pin	NONE
Pull to Load ( <i>optional function</i> )	Disabled
Force	50.0 lbF
Load Holding ( <i>optional function</i> )	Disabled
Hold Force	40.0 lbF
Time	1 min.
Date & Time ( <i>optional function</i> )	Varies
Profile name ( <i>optional function</i> )	(blank)
Tones	
Keys	Enabled
Alerts	Enabled
Pass / Fail Limits	Momentary
Initial Settings	
Unit	lbF
Mode	Real Time
Passwords	All passwords disabled

## 24.3 Dimensions

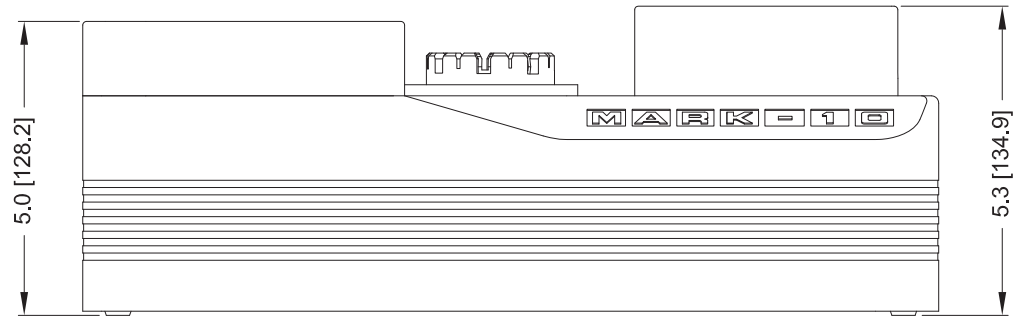
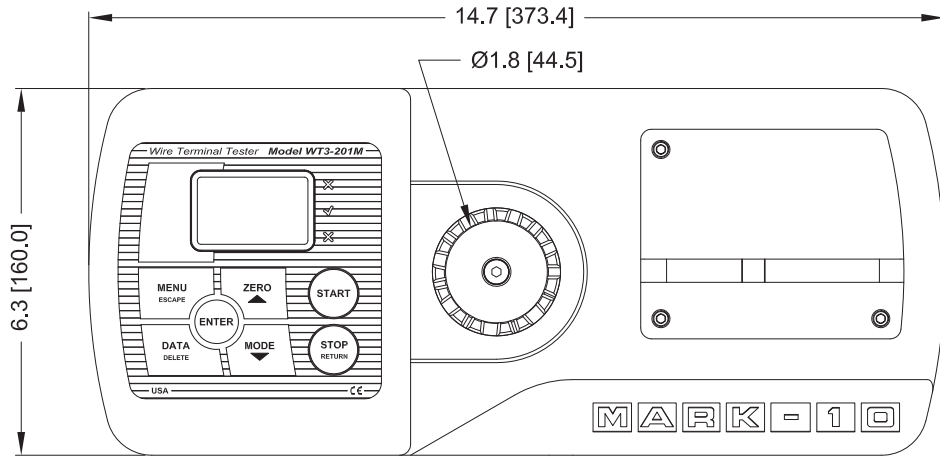



*Mark-10 Corporation has been an innovator in the force and torque measurement fields since 1979. We strive to achieve 100% customer satisfaction through excellence in product design, manufacturing and customer support. In addition to our standard line of products we can provide modifications and custom designs for OEM applications. Our engineering team is eager to satisfy any special requirements. Please contact us for further information or suggestions for improvement.*



*Force and torque measurement engineered better*

**Mark-10 Corporation**

11 Dixon Avenue  
Copiague, NY 11726 USA  
1-888-MARK-TEN  
Tel: 631-842-9200  
Fax: 631-842-9201  
Internet: [www.mark-10.com](http://www.mark-10.com)  
E-mail: [info@mark-10.com](mailto:info@mark-10.com)