

Operating Instructions

Stripping machine **ST215 / ST215W**



V2.1 (based on V2.1 German)

Please read through these Operating Instructions carefully before starting work.

General

We thank you for your confidence in our company and that you have decided upon our centering device. To be able to achieve the optimum performance please read these Operating Instructions with due care and attention. In the event of damage caused by not following these instructions any guarantee claims will be null and void. We will also not accept any liability for consequential damages.

Table of Contents

Table of Contents	2
Symbols	3
Product description	3
Centering device (Optional)	3
Connecting the machine	4
Control Elements	4
<i>Placing in operation</i>	5
<i>Setting the centering device</i>	5
<i>Setting the Diameter</i>	5
<i>Setting the Wayback (ST215W only)</i>	6
<i>Setting the Length</i>	6
<i>Setting the rotation duration / incision rate</i>	7
<i>Counterclockwise or clockwise rotation / no rotation</i>	7
Maintenance	9
<i>Lubrication</i>	9
<i>Cleaning</i>	9
<i>Changing the stripping blades</i>	9
<i>Dismantling the centering unit</i>	11
<i>Assembling the centering device</i>	12
<i>Fit the stripping blades and calibrating the centering unit</i>	13
Error sources.....	14
<i>Faults on cable</i>	14
Basic Equipment, Spare Parts, Options	16
<i>Basic Equipment ST215</i>	16
<i>Spare Parts</i>	16
<i>Options</i>	17
Technical Data	17

Symbols

 Please adhere strictly to the work practices and procedures indicated by this pictogram. Non-adherence could cause damage to the tool or the cable.

 This pictogram serves to illustrate the working and operating procedures which must be adhered to, as well as to give important information about how the tool works.

Product description

The ST215 is a high precision stripping and twisting machine specially developed for stripping small diameter cables. High quality machining together with high grade materials render the ST215 a robust production machine.

The ST215 is a true all-rounder; it masters the stripping of standard cables in short cycles also micro-coaxial cables with the highest precision. The absence of gripper jaws enables the ST215 to process the shortest of cable ends, crushing of the sheath being also ruled out. The patented **4-blade system** permits the stripping of cable ends with total and repeatable accuracy.

The sheath is removed by a rotary incision with subsequent pulling-off in a single operation. The ST215 can be steplessly set to a different diameter or length in seconds by means of a scale.

System overview:

- Rotary incision
- Stripping head with a 4 blade system in one plane
- Knife changing performed without tools
- Stepless setting of diameter and length by means of a scale

 The ST215 is intended exclusively for stripping copper conductors. Take care to ensure that no metal objects (e.g. screwdrivers, tweezers) come into contact with the blades where they can cause damage.

Centering device (Optional)

The purpose of the steplessly adjustable centering is to ensure that the cable is aligned accurately with the centre of the blades. If your ST215 has been delivered without a centering device, this can be retrofitted without problems.

The advantages of the centering device are as follows:

- Influencing of the stripping quality by the user is practically ruled out.
- The stripping diameter can be set very close to the conductor, enabling very thin walled insulations to be stripped without problem.

Connecting the machine

- Connect the machine to the voltage supply and the connection marked „24V DC“ with the mains power unit. If the mains connector plug is not compatible with your mains supply socket, please contact your Nitronic supplier or us directly.
- Connect the machine to your compressed air supply system. The supplied compressed air hose is fitted with a coupling on the machine side, the other side is free. You must fit a coupling to this free side which is compatible with your compressed air system. The outer hose diameter is 6 mm.

 The machine is equipped with an internal pressure controller; however the incoming pressure must be between 5 and 8 bar. The pressure is in no case to exceed 8 bar!

- Connect the foot pedal switch (optional) to the connection „Foot Pedal“.

 With the foot pedal connected, the activation sensor is inactive! The machine can only be activated with the foot pedal!

Control Elements

4. Diameter

5. Stripping head with length scale

2. Length

17. Centering

31. Rotation time / diameter feed rate

30. Counterclockwise / no rotation / clockwise

32. Wayback (ST215 only)

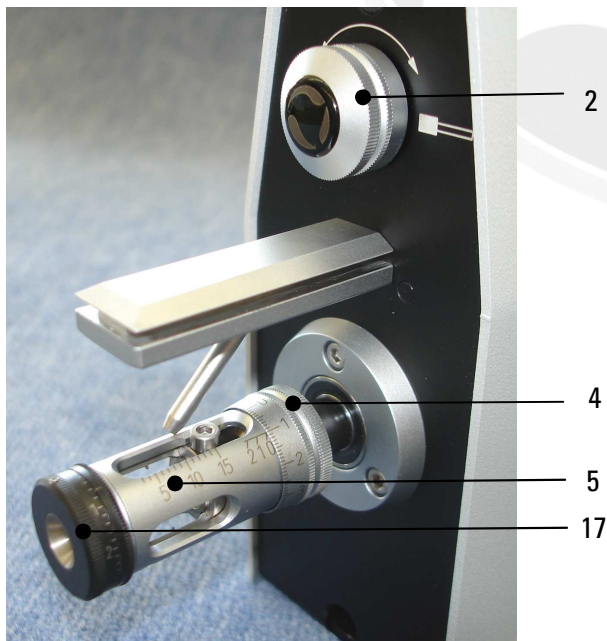

Fig. 1

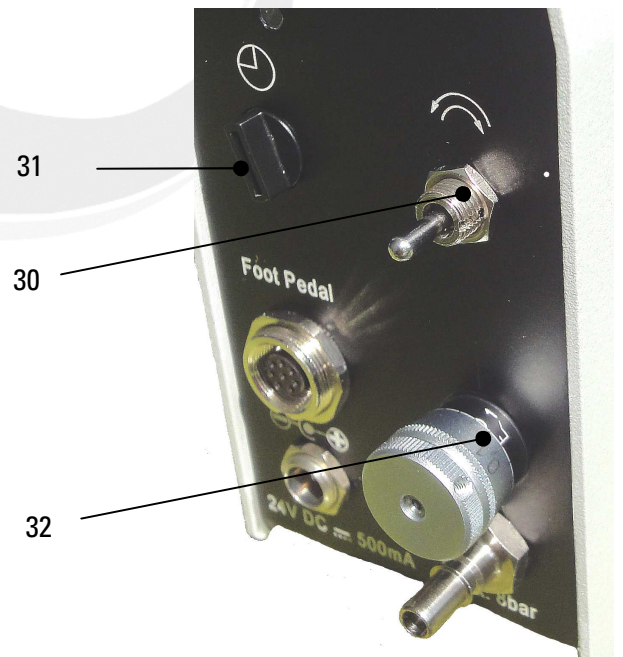



Fig. 2

Placing in operation

 The order of the settings must be observed because due to the construction, any changes to the stripping diameter will render it necessary to make adjustments to the stripping length!

The protective cover must be removed for settings to the stripping head, i.e. the centering device or the stripping diameter. This can be removed or refitted by simply pulling out or pushing in. The protective cover must be pushed right up to the front panel; remove any scraps of cable between the cover and the front panel.

 For safety reasons the machine cannot be started without the protective cover in place!

The blue LED will blink 3 times if the cover is not mounted and you try to start the stripping cycle.

Setting the centering device

- Measure the external diameter, e.g. with the slide gauge or centering device open; introduce the cable and close the centering device.
- The cable must in no event be clamped but should be movable in the centering device without play.

 Special regulations, (e.g. military) stipulate blocking of the centering device. This can be carried out with the light Allen screw, using the Allen key supplied.

 No not confuse the light Allen screw with the black one. If you should slacken the black Allen screw, the centering device will be displaced and will have to be recalibrated.

Setting the Diameter

- Evaluate the cable conductor diameter, e.g. with the sliding gauge.
- Check that the Wayback is set to 0 (ST215W only).
- Then set a somewhat large value at the diameter scale (**ca. + 0.1mm or 0.01 Inch**). The diameter scale is graduated in **0.01mm (0.001 Inch)**.

 When setting the diameter, always turn from a larger diameter to the desired value. For example; if the existing setting is 0.95mm and you wish to set 1.00mm, first open to ca. 1.50mm and then turn to 1.00mm.

 If the stripping diameter is set too small, the blades will cut into the conductor and a high pulling force will be required to pull off the insulation. This can damage the blades.

- If required, the diameter adjustment can be blocked with the supplied grub screw. Remove the existing grub screw at the side of the diameter adjustment using the Allen key supplied, and carefully screw in the longer grub screw as far as the stop.

Setting the Wayback (ST215W only)

The Wayback is an opening of the blades before pulling off the jacket.

i The Wayback is only active when pulling off without rotation. The Switch 30 must be in the middle position.

- Set the Wayback to 0.00mm firstly
- Raise the Wayback until the desired stripping results are reached.
- The Wayback scale is graduated in **0.01mm (0.0005 Inch)**. That means that with a full turn the Wayback will be 0.2mm (0.008 Inch) in diameter.

Setting the Length

- Set the desired stripping length with the length setting knob and read off the length at the length scale.



Fig. 3

Setting the rotation duration / incision rate

The rotation duration and the incision rate are selected with the same switch. The longer the setting of the rotation duration, the shorter the incision rate. At step 0, i.e. the shortest rotation duration, the blades close very quickly. At step 9, the longest rotation duration, the blades close very slowly.

 The stripping head may not be externally braked whilst running. Otherwise there is no guarantee that the blades will close to the set diameter, particularly with step 9.

Counterclockwise or clockwise rotation / no rotation

The desired rotation direction can be set with the changeover switch. This is especially important for the twisting of stranded wires. The correct choice of rotation direction can also positively influence stripping quality when stripping micro-coaxial cables.

ST215W only:

In the middle position, the stripping head will stop. Then you can pull off the cable while the blue LED is on. After that the machine starts the cleaning cycle.

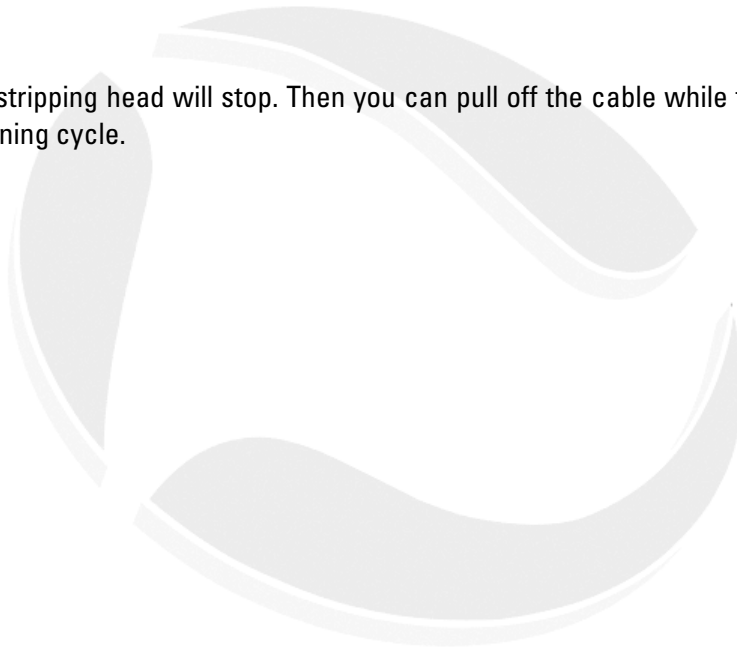

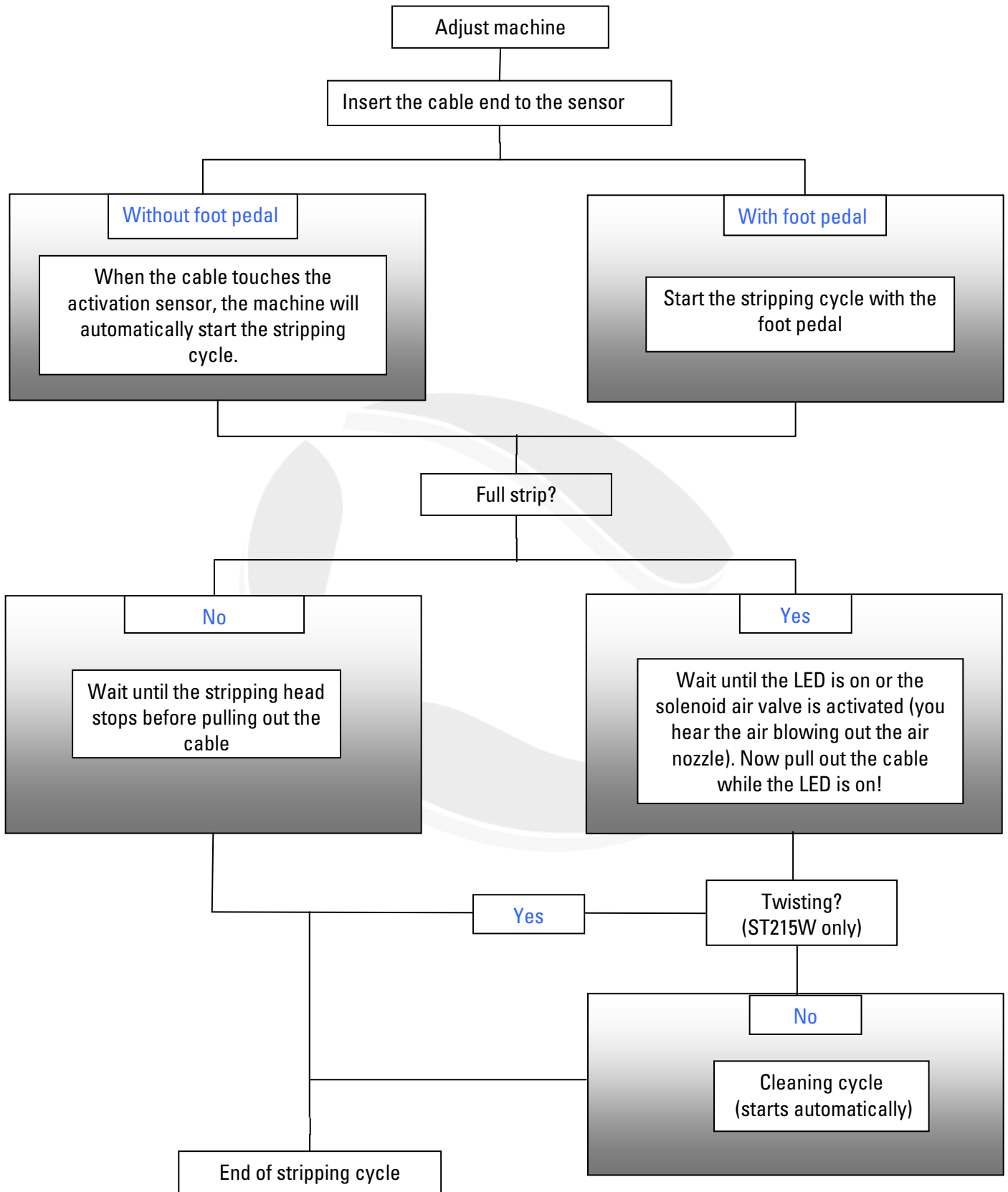



Fig. 4

Maintenance

The only maintenance required is cleaning of the stripping head.

Lubrication

 The ST215 is designed in such a way that it does not require the application of grease or oil. In order to ensure correct function and long service life avoid contaminating the tool with greasy or oily substances.

Cleaning

The waste created by the stripping should be automatically removed by the air blast.

- Clean the surface of the stripping head using a dry, clean brush only.
- Dirt on the housing or the stripping head can be removed using a cloth dampened with kerosene.

 Do never use solvent like thinner to clean the machine!

Changing the stripping blades

 The stripping blades may only be inspected and replaced by a suitably trained person.

- Remove the power cord, foot pedal and compressed air.
- To facilitate the handling with the machine, arrange the machine with aid of the bench clamp. See Fig. 5.
- Set the diameter setting to 0.2mm (0.008 Inch).
- Set the length setting to the hindmost position.



Fig. 5

- Insert the position retainer corresponding to Fig. 6 in hat stripping head. For this, slide the big Allen screw near the length scale, to the back. This procedure allows to easily insert the new blades.
- If the centering unit is blocked, loose the bright and small Allen screw.
- Loose the black and small Allen screw of the centering unit.
- Loose the entire centering unit and pull it out

Fig. 7.



Fig. 6

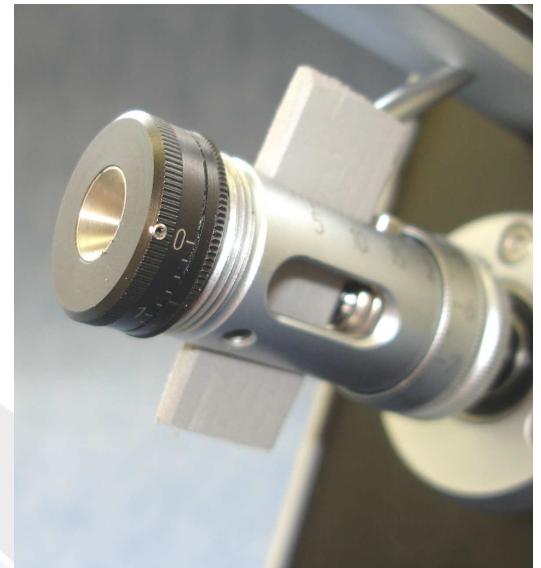

Fig. 7

Now you can see the four stripping blades

Fig. 8

i In order to avoid losing the very small stripping blades, we recommend that you put down a dark-colored, smooth mat and use a pair of tweezers.

i All four stripping blades must be changed at the same time in order to maintain a consistent stripping quality.

- Remove each stripping blade **(8)** individually from the guide plate **(9)**.
- If necessary, carefully clean the guide plate **(9)** with a dry brush
- Insert new stripping blades **(8)** individually. As far as possible, align the stripping blades accurately with the track so that the blades do not subsequently jam.
- Insert the centering unit carefully, but **do not yet tighten it**.
- Remove the position retainer.
- Set the diameter scale to 0.0mm (0.0 Inch).



Fig. 8

- Slowly push the big Allen screw **(6)** back and forth. This will cause the four stripping blades to automatically fit into the tracks on the guide plate Fig. 9.
- Only now tighten the centering unit.

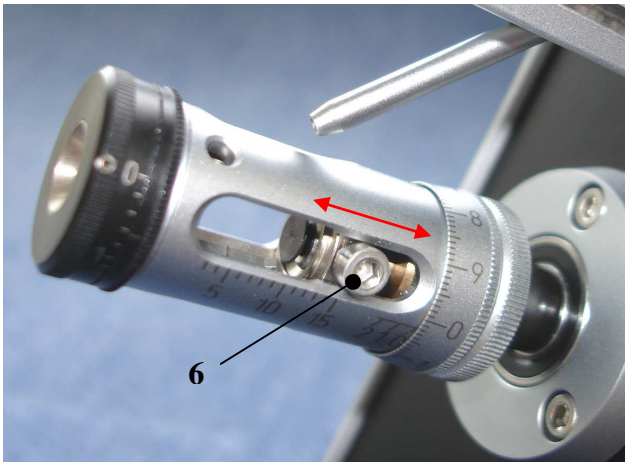

Fig. 9

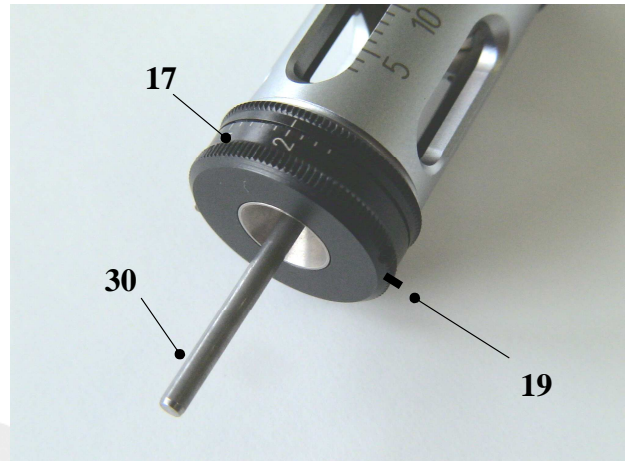

Fig. 10

- By rotating the centering scale **(17)**, fully open the centering jaws **(25)** and insert the calibrating pin **(30)**. Then by rotating the centering scale **(17)** close the centering jaws as far as the calibrating pin **(30)** Fig. 10.
- Loosen screw **(19)** (black) and turn the centering scale **(17)** clockwise to diameter **2.0 mm**. Retighten screw **(19)** (black) and remove calibrating pin **(30)**.

The ST215 is now ready for use.

Dismantling the centering unit

- Loosen screw **(19)** (black) and remove centering scale **(17)** with a slight turning movement Fig. 11.
- Lift off the O-ring **(20)** and take it out Fig. 12.



Fig. 11

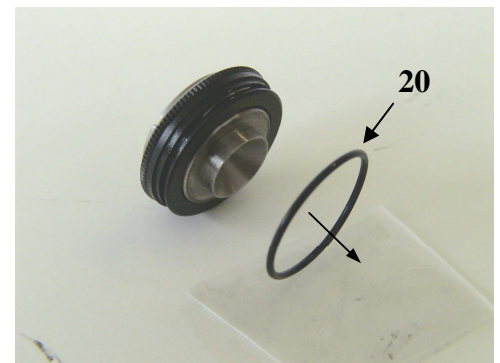

Fig. 12

Push the two keys **(22)** out of the guides with a pair of tweezers and remove them Fig. 13.

- The guide plate **(23)**, the centering jaws **(25)** and the helixes **(26)** can now be removed together Fig. 14.

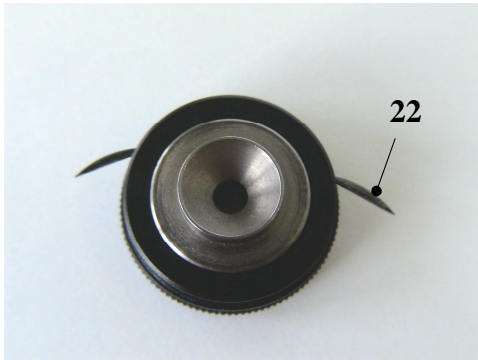

Fig. 13

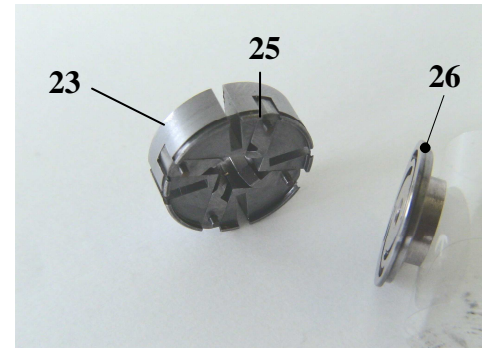

Fig. 14

Assembling the centering device

- Reinstall guide plate **(23)** and insert the centering jaws **(25)** individually Fig. 15.
- Push all four centering jaws **(25)** outwards to the stop on the stripping head and carefully put the helixes **(26)** in place Fig. 16.

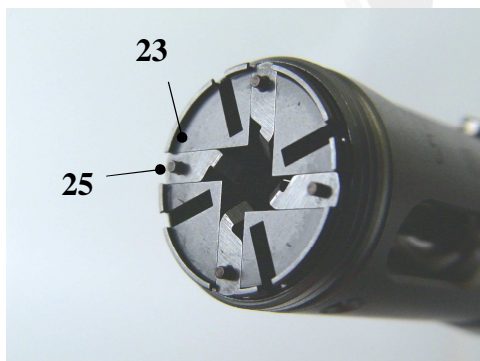

Fig. 15

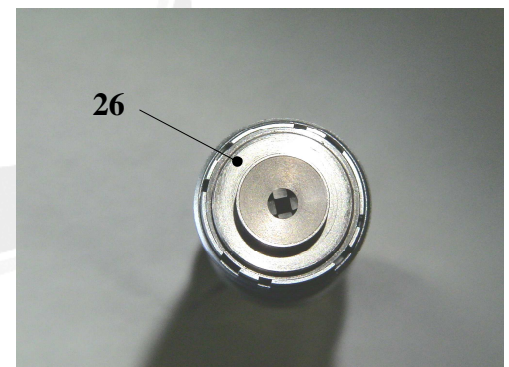

Fig. 16

- By rotating the helixes **(26)** check that the centering jaws can close smoothly and simultaneously. If necessary repeat the procedure.

- Screw on nut **(18)** and tighten up Fig. 17.

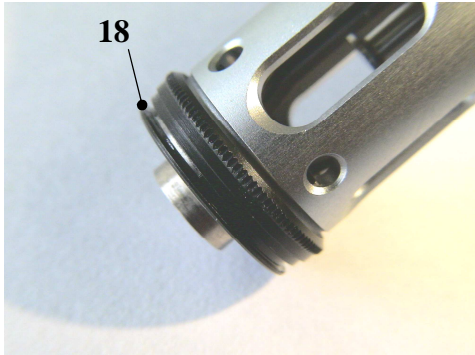

Fig. 17

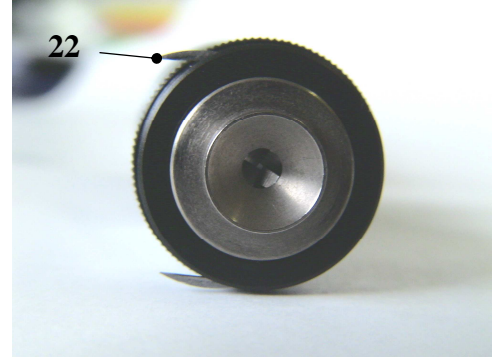

Fig. 18

- Insert the two keys **(22)** and install the previously-greased O-ring **(20)** Fig. 18.

 The two keys **(22)** must be inserted flush with the inside diameter of the slot.

- Push centering scale **(17)** with a slight turning movement to the stop but do not yet tighten screw **(19)** (black) Fig. 19.

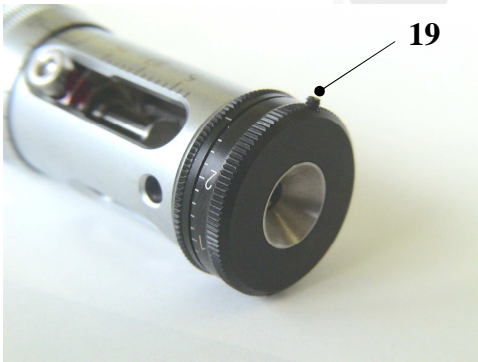



Fig. 19

 If the centering scale **(17)** cannot be pushed over the O-ring the two keys **(22)** are not properly.

The centering device must now be calibrated in the next operating step.

Fit the stripping blades and calibrating the centering unit

- Loosen the centering unit so that it is not tightened.
- Set the diameter scale to 0.0mm (0.0 Inch).
- Slowly push the big Allen screw **(6)** back and forth. This will cause the four stripping blades to automatically fit into the tracks on the guide plate Fig. 20.
- Now tighten the centering unit.



Fig. 20

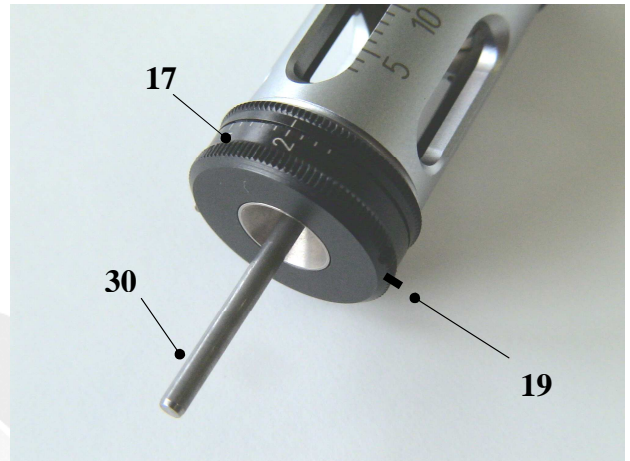

Fig. 21

- Tighten a bit the screw **(19) (black)**
- By rotating the centering scale **(17)**, fully open the centering jaws **(25)** and insert the calibrating pin **(30)**. Then by rotating the centering scale **(17)** close the centering jaws as far as the calibrating pin **(30)** Fig. 21.
- Loosen screw **(19) (black)** and turn the centering scale **(17)** clockwise to diameter **2.0 mm**. Retighten carefully screw **(19) (black)** and remove calibrating pin **(30)**.

The ST215 is now ready for use.

Error sources

Faults on cable

Fault	Diagnosis	Fault rectification
Inside conductor, screen or dielectric cut into	Cable is very eccentric	Reduce centering diameter in steps
Jacket cannot be stripped off	Very small difference in diameter between Jacket and conductor.	Reduce centering diameter in small steps

Faults on machine

Fault	Diagnosis	Fault rectification
Can not insert the cable	Cable rests in the stripping head	Clean, with starting the stripping cycle several times.
Bad stripping quality	Stripping blades are broken or used	Change the stripping blades
The blue LED is blinking 3 times	The safety shield is not mounted	Insert the safety shield



Basic Equipment, Spare Parts, Options

Basic Equipment ST215

Qty.	Description	Article Number
1	Stripping machine ST215 / ST215 Inch	010083 / 010307
1	Stripping machine ST215W / ST215W Inch	010305 / 010314
1	Bench clamp	010177
1	Power supply with Adapter Set	010113
1	Coupler for air hose	010151
1	Allen key for diameter blocking	EN-7411
1	Stud screw for diameter blocking	BN-617 M2x8
1	Position retainer	ST-0900
1	Operating Instructions English or Operating Instructions German	EN-7120E EN-7120D
1	Allen key for centering unit	EN-7412
1	Calibrating mandrel	BN-1208

Spare Parts

Qty.	Description	Article Number
1 Set	Stripping blades HSS (4 pcs.)	010075
1 Set	Stripping blades Titanium coated carbide (4 pcs.)	010079
1 Set	Input connectors for power supply (EU, USA, UK, SAA)	010115
1	Cover	010322
1	Length button	010404
1	Guide plate	010225
1	Solenoid air valve	010149
1	Blocking screw M1.4 x 2.5	BN-24 M1.4x2.5
1	Stud screw for diameter blocking	BN-617 M2x8
	Sealing Cap with Nitronic Logo	010216

Options

Qty.	Description	Article Number
1	Foot pedal	010084
1	Micro Filter	010346
2	Port for Micro Filter straight	010347

Technical Data

Wire size range	0.08 mm (0.003") to 2.00 mm (0.08") (12 – 40 AWG)
Outer cable diameter max.	2.5 mm (0.1")
Stripping length	up to 13mm
Cycle time	0.3 sec. up to 6.2 sec. (stripping cycle), 10 different steps
Rotation / Twisting	Clockwise / Counter clockwise
Diameter Scale	0.01 mm (0.001 Inch)
Wayback Scale (ST215W only)	0.01 mm (0.0005 Inch)
Length scale	1.0 mm (.06 Inch)
Dimensions	LxWxH 210 x 54 x 126 mm (10 x 2.2 x 5 Inches)
Weight	850g
Stripping blades	4 pcs. Carbide, Titanium coated
Power supply (Primary)	100-230 VAC, < 0.6A RMS, 47-63 Hz
Power supply ST215 (Secondary)	24 VDC
Compressed air	5 to max.8 Bar
Outer hose diameter	6mm (0.24")

We reserve the right to make technical changes at any time!

ABE.TEC

ABE.TEC, s.r.o., čp.43,
530 02 Ostřešany, ČR
www.abetec.cz